



INOGENI U-BRIDGE 3

User guide

Version 1.2

December 17, 2024

VERSION HISTORY

Version	Date	Description
1.0	October 11, 2024	Preliminary user guide for device launch.
1.1	October 18, 2024	Updated package content.
1.2	December 17, 2024	Adding precision on leds behavior. Updated mechanical drawings. Updated certifications.

CONTENTS

Version history	1
Introduction	2
Connectivity diagram	2
Device interfaces	3
LEDs behavior	4
Specifications	5
Serial CONNECTION.....	6
INOGENI Maestro application.....	7
Mechanical specification	8
PCHOST module.....	8
DEVICE module	9
INO – MOUNT	10
Power supply	11
Troubleshooting section.....	12
Support.....	13
Certifications	13

INTRODUCTION

The U-BRIDGE 3 is a USB 3.2 Gen 1 extension over CAT6A that can extend a 5Gbps signal between a host and devices. This is a two-boxes solution, which are called PCHOST and DEVICE modules.

CONNECTIVITY DIAGRAM

Here is a simple U-BRIDGE 3 connectivity diagram. You can plug the power supply to any module to power up the whole system.

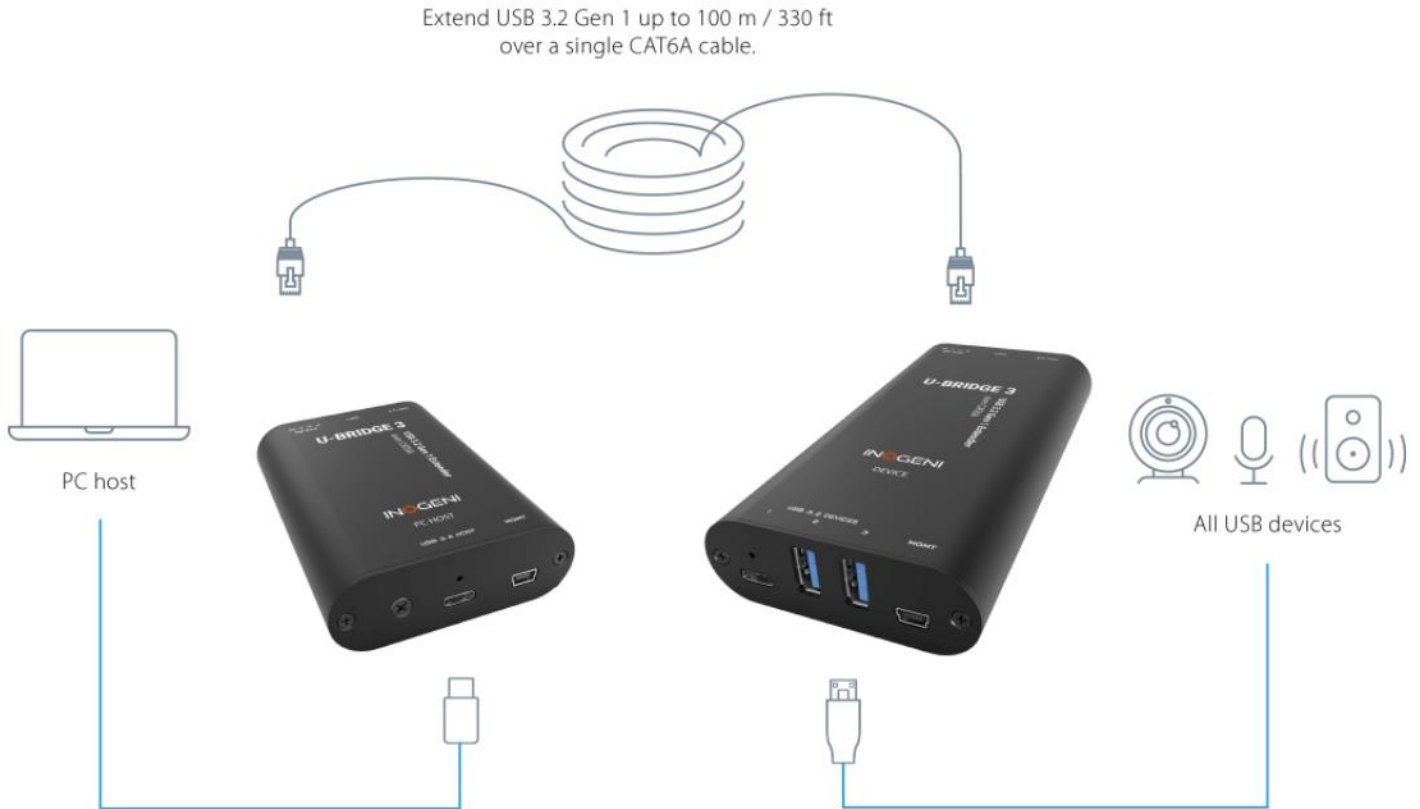

DEVICE INTERFACES

Here are the devices interfaces.

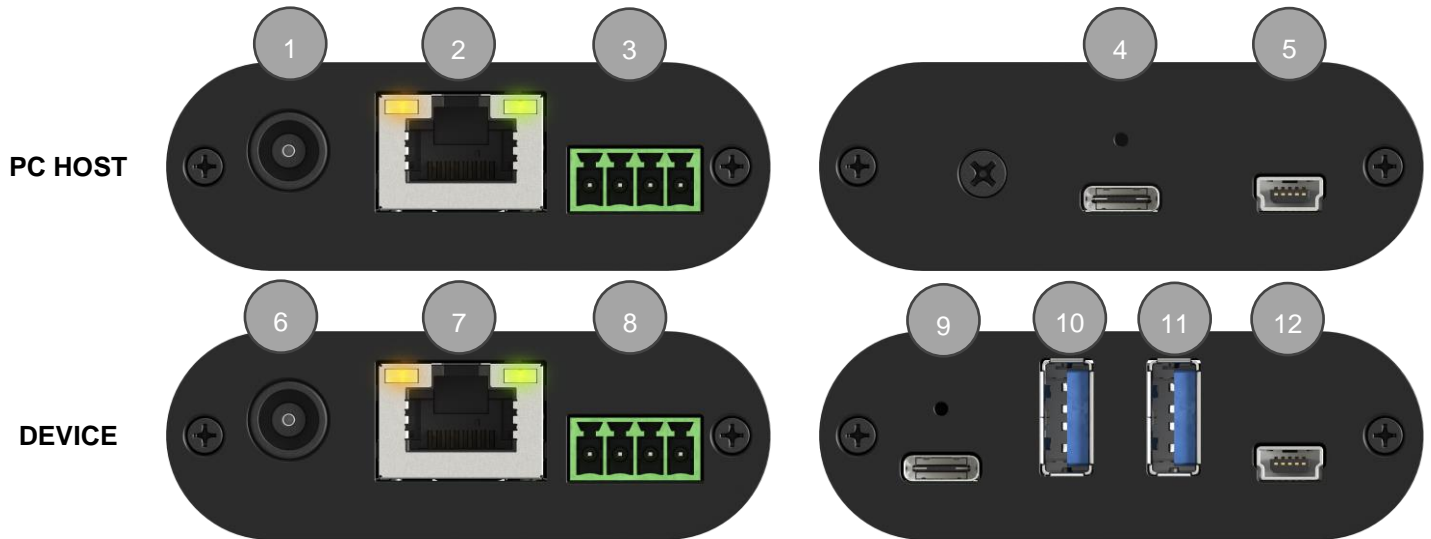

Items		
PC HOST	1	+24VDC power input. If power supply is connected here, the DEVICE side will be powered using PoC through the HDBaseT link.
	2	HDBaseT link.
	3	RS232 connection.
	4	USB-C host connection.
	5	USB-mini management connection.
DEVICE	6	+24VDC power input. If power supply is connected here, the DEVICE will be powered locally.
	7	HDBaseT link.
	8	RS232 connection.
	9	USB-C device connection.
	10	USB-A device connection.
	11	USB-A device connection.
	12	USB-mini management connection.

LEDS BEHAVIOR

Here are the LEDs behavior on the HDBaseT link connection:

GREEN LED	
OFF	No power.
SOLID	System powered with USB 3.0 connection.
BLINK	System powered. Led blinks over a USB2.0 connection if HDBaseT link is valid. Led blinks if no HDBaseT link.
ORANGE LED	
OFF	No HDBaseT connection detected.
SOLID	HDBaseT connection detected.

SPECIFICATIONS

Here is the complete specification.

Main feature	
Description	The U-BRIDGE 3 USB 3.2 Gen 1 extender enables superspeed USB 3.0 connection of up to 100m/330ft. over a single CAT6A
Link	
Technology	HDBaseT-USB3
Range	Direct connect up to 100m (330ft) over CAT6A U/FTP
Medium	CAT6A U/FTP NOTE: We do not recommend using a crimp tool for attaching terminations. Instead, we highly recommend utilizing toolless terminations to ensure the preservation of signal integrity.
USB	
Speeds	USB 3.2 Gen1 / USB 3.1 Gen1 / USB 3.0: up to 5 Gbps USB 2.0: up to 480 Mbps NOTE: USB-C DisplayPort Alternate Mode is not supported.
Transfers support	Bulk, isochronous, interrupt and control types Built-in hardware acceleration for isochronous and bulk transfers
PC Host extender	
USB connector	1 x USB Type-C receptacle with mounting screw hole
Link connector	1 x RJ45
Dimensions (W x L x H)	7.0 cm x 9.7 cm x 2.3 cm 2.76" x 3.82" x 0.90"
Weight	170 g (0.37 lb)
Mounting	Bracket provided
Enclosure material	Black anodized aluminum case
RS232 connector	Passthrough serial connection By default, I/O pin is an input. +1.8V logic (maximum)
Device extender	
USB connector	2 x USB-A receptables 1 x USB-C receptacle with mounting screw hole
Link connector	1 x RJ45
Available current	Up to 1.8A shared between ports
Dimensions (W x L x H)	7.0 cm x 13.7 cm x 2.3 cm 2.76" x 5.39" x 0.90"
Weight	210 g (0.46 lb)
Mounting	Bracket provided
Enclosure material	Black anodized aluminum case
RS232 connector	Passthrough serial connection. By default, I/O pin is an output. GND or OPEN
Physical details	
Package dimensions	24.5 cm x 25 cm x 7.9 cm 9.69" x 9.84" x 3.11"
Power supply	100-240V AC Input, 24V 1.5A DC output. Apply at either PC HOST or DEVICE modules
Package weight	1200 g (2.65 lbs)
Package contents	1x PC Host extender module 1x Device extender module 1x USB 3.0 Type-C to Type-C cable 1x Quick Start Guide 2x mounting brackets (power supply) 2x mounting clips

	2x terminal blocks 4x black wooden screws 1x power supply 100-240V AC Input, 24V 1.5A DC output International power adapter with country-specific cord (North America, EU, UK, Australia/NZ, or Japan)
Operating temperature	0°C to 50°C 32°F to 122°F
Storage temperature	-20°C to 70°C -4°F to 158°F
Operating humidity	20% to 80% relative humidity, non-condensing
Storage humidity	10% to 90% relative humidity, non-condensing

Information	
UPC code	051497429522
Origin	Canada
Warranty	5 years

SERIAL CONNECTION

Here is the serial connection of the U-BRIDGE 3. A serial port from a DUT can be extended when using our device.

This is the pinout of the serial connection:



Pin 1: Receive

Pin 2: GND

Pin 3: Transmit

Pin 4: I/O

The direction of the I/O pin can be configured through the Maestro software.



NOTE: By default, the PC HOST I/O pin is an **input** and DEVICE I/O pin is an **output**.

You can use our [INOGENI Maestro](#) application to monitor firmware information, link status and upgrade your units.



NOTE: You can use our Maestro software when the kit (PCHOST / CAT6A cable / DEVICE) is connected to your computer using the USB-C connection on PCHOST module. You can also use the USB-mini connector to monitor / upgrade the modules.

This is a preview of the upcoming Maestro application. More detailed configurations will be added to an updated version of the user guide.

Maestro Version – V1.0.0

INOGENI

DEVICE DETECTED

U-BRIDGE 3

U-BRIDGE 3

GENERAL

PC HOST - Firmware version	1.0.7
DEVICE - Firmware version	1.0.7
Serial number	UBRXXXXXX

LINK

	Active / Inactive
Link	N/A / C m
Estimated distance	
Signal integrity	OK
Pair A	OK
Pair B	OK
Pair C	OK
Pair D	OK

REBOOT DEVICE

LAPTOP HOSTS THE MEETING

STATUS SETTINGS SYSTEM RESOURCES PREVIEW

Maestro
Device controller

MECHANICAL SPECIFICATION

You can find the mechanical specification of the device. All dimensions are in **mm [in]**.

PCHOST MODULE

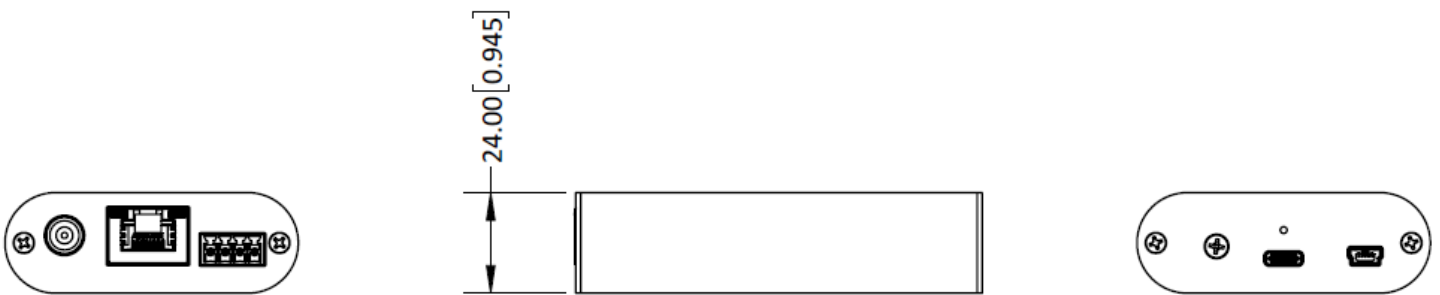
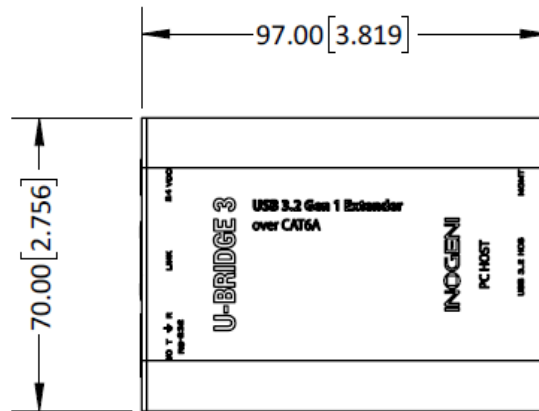
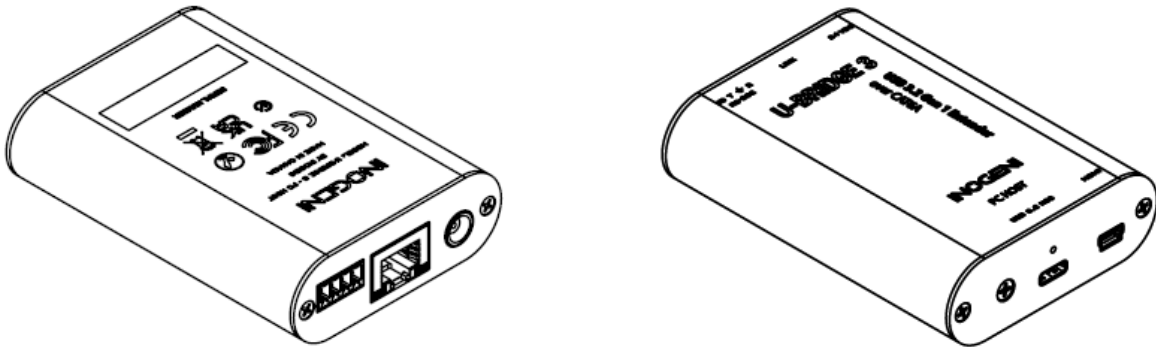

Figure 1: PC HOST module dimensions

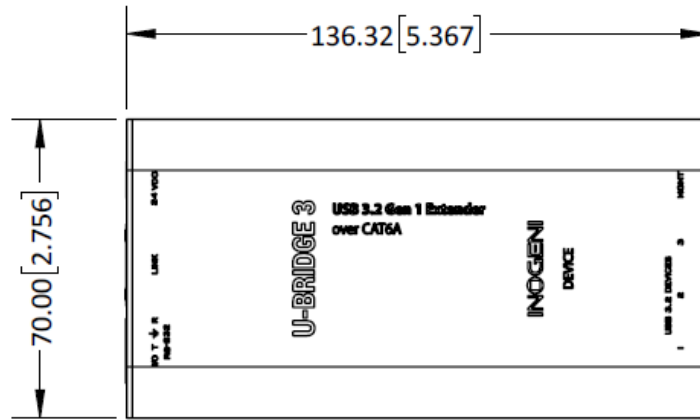
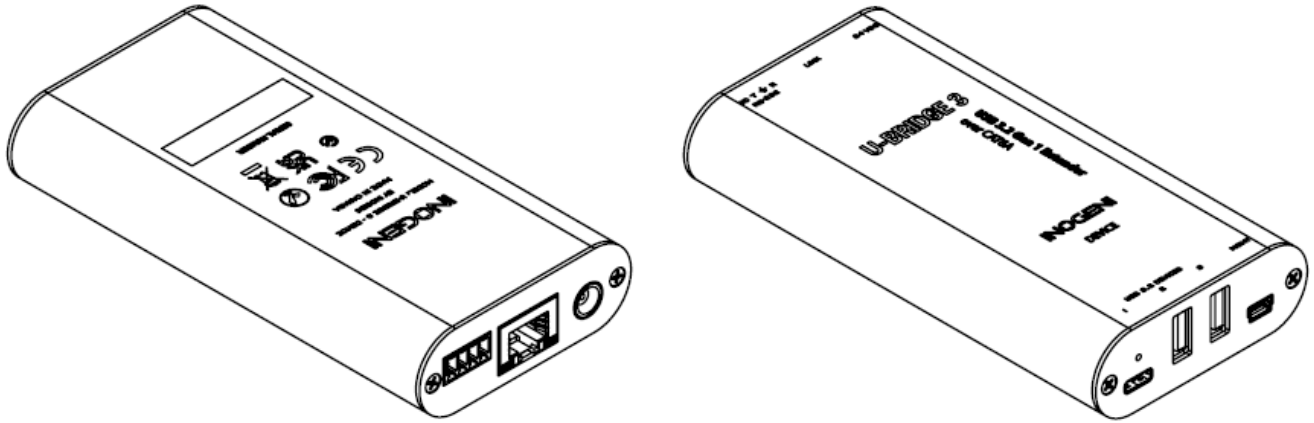
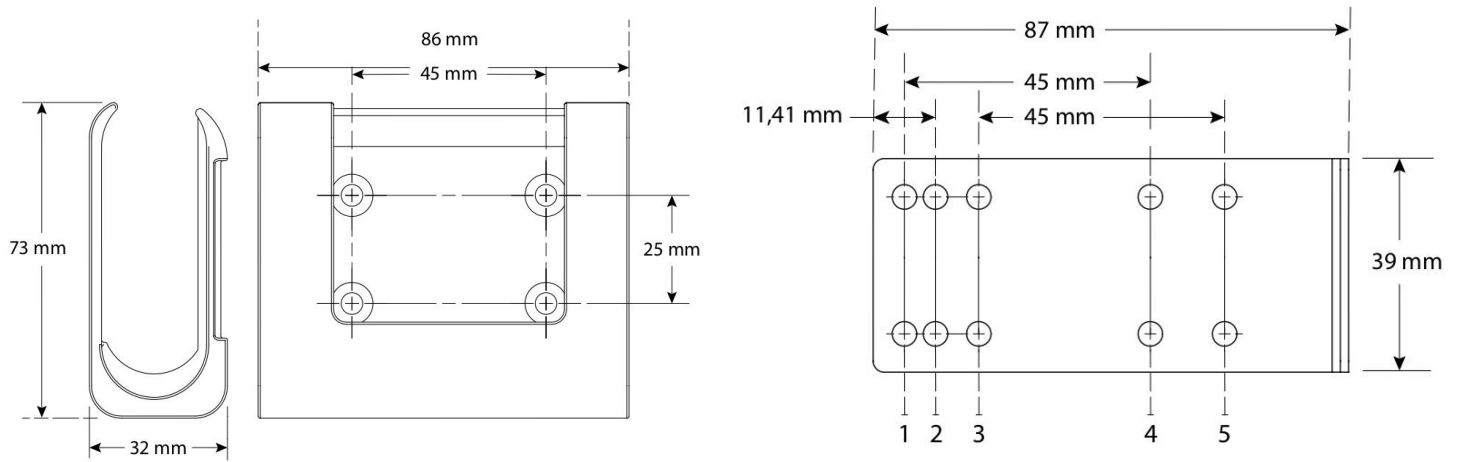
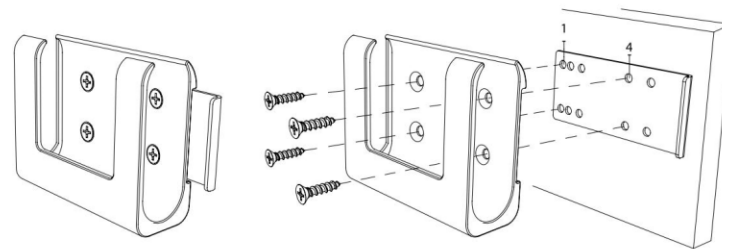

Figure 2: DEVICE module dimensions



Screw into holes 1 and 4

- 4KX-PLUS
4K HDMI to USB 3.0 capture device
(+ HDMI loop, analog audio & external power)
- 4KXUSB3
4K Ultra HD to USB 3.0
(+ HDMI loop, analog audio & VISCA)
- U-BRIDGE 3 - PC HOST
USB 3.2 Gen 1 camera and device extender



Screw into holes 2 and directly into the surface

- U-BRIDGE 3 - DEVICE
USB 3.2 Gen 1 camera and device extender

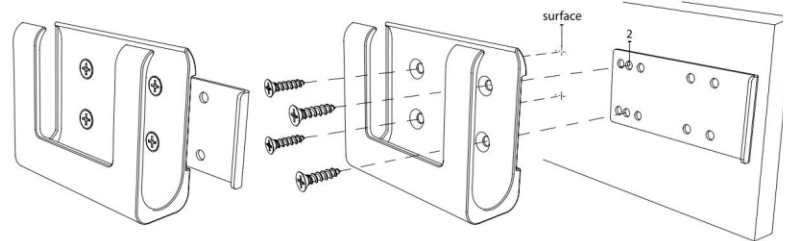
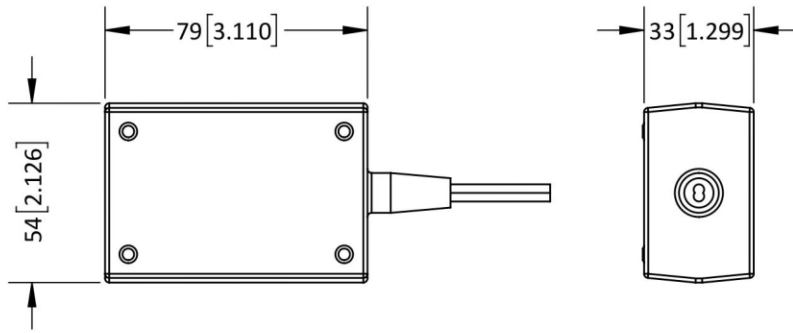
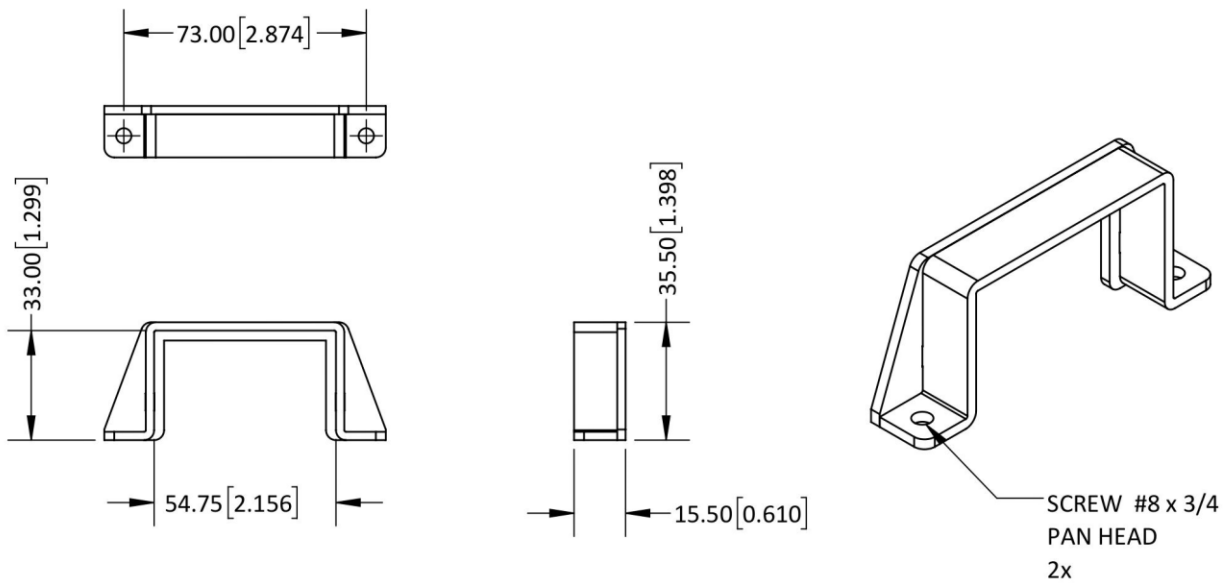

Figure 3: Bracket dimensions



POWER SUPPLY



MOUNTING BRACKET for POWER SUPPLY

Figure 4: Power supply bracket dimensions

TROUBLESHOOTING SECTION

Here is the troubleshooting section for the device.

Problem	Resolution
Green LED is blinking slow Orange LED is OFF	PC HOST side is not connected to a PC or HDBaseT cable is not working properly.
Green LED is blinking slow Orange LED is ON	PC HOST side is not connected to a PC.
Green LED is blinking fast	There is a firmware problem, connect the USB-C PC HOST port and mini-USB management port to a PC running Maestro for firmware upgrade.
Green LED is OFF Orange LED is OFF	PC HOST side: No power from the USB-C port of the host PC. DEVICE side: No power to the 24VDC port on either HOST side (via PoC) or DEVICE side (direct), or HDBaseT cable is not connect or not working properly if using PoC.
Unstable USB 3.0 connection	HDBaseT cable is too long or not working properly. USB cables are too long or not working properly.
USB 3.0 ports are shutting down	Too much power drawn on USB ports, the maximum current consumption is 1.8A total for the 3 ports.
Using a USB-C to USB-A adapter, my USB 3.0 devices are detected in USB2.0 mode only on my computer.	Most of passive USB-C to USB-A adapters support USB3.0 on one side of the USB-C connection. Flip by 180 degrees the USB-C connection next to the adapter to see if this resolves the issue.
I cannot extend USB-C video from laptop to my USB-C monitor	The device does not support USB-C DisplayPort Alternate Mode.

Engineered by video professionals, for video professionals, it is your most compatible USB 3.0 device. INOGENI expertise at your fingertips:

- **Expert Technical Support team** at support@inogeni.com for immediate help or if you have any technical question about our products.
- Extensive **Knowledge Base** to learn from other customers' experiences.

© Copyright 2024 by INOGENI INC. All Rights Reserved.

INOGENI name and logo are trademarks or registered trademarks of INOGENI. Use of this product is subject to the terms and conditions of the license and limited warranty in effect at the time of purchase. Product specifications can change without notice.

INOGENI, Inc.
1045 Avenue Wilfrid-Pelletier
Suite 101
Québec, QC, Canada, G1W0C6
(418) 651-3383

CERTIFICATIONS

 **FCC Radio Frequency Interference Statement Warning**
This device complies with Part 15 of the FCC rules. Operation is subject to the following two conditions:
(1) this device may not cause harmful interference, and
(2) this device must accept any interference received including interference that may cause undesired operation.

IC Statement
This Class A digital apparatus complies with Canadian CAN ICES-3(A)/NMB-3(A).

 **CE Statement**
We, INOGENI Inc., declare under our sole responsibility that the Toggle Rooms, to which this declaration relates, is in conformity with European Standards EN 55032, EN 55035, and RoHS Directive 2011/65/EU + 2015/863/EU.

 **UKCA Statement**
This device is compliant with the Electromagnetic Compatibility Regulations 2016 No. 1091 as part of the requirements leading to the UKCA marking.

 **WEEE Statement**
The European Union has established regulations for the collection and recycling of all waste electrical and electronic equipment (WEEE). Implementation of WEEE regulations may vary slightly by individual EU member states. Please check with your local and state government guidelines for safe disposal and recycling or contact your national WEEE recycling agency for more information.

 **RCM Statement**
This device is compliant with Regulator Compliance Mark (RCM) certification.

 **NOM Statement**
This device is compliant with the NOM-019 standard.